

Intrinsically safe solenoid directional valves

Poppet type, leak free, direct operated - **ATEX** or **IECEX**

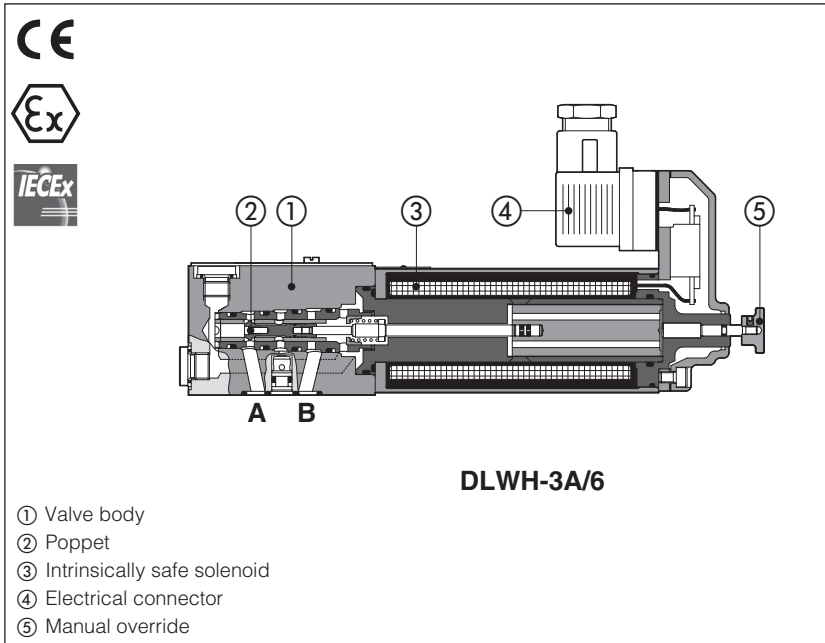

DLWH

Poppet type, direct operated valves designed for application in hydraulic systems with leak-free requirements and equipped with intrinsically safe solenoids certified for safe operation in hazardous environment with potentially explosive atmosphere.

Certifications:

- **ATEX** or **IECEX**:
II 1G Ex ia IIC, IIB, IIA
surface plants zone 0, 1 and 2

- **ATEX** or **IECEX**:
IM2 Ex ia IMb, Ex ib IMb
surface, tunnels or mining plants

See section 7 for certification data

The valves must be electrically powered through specific "safety barriers" limiting the max current to the solenoid, see section 12

Size: **06**

Max flow: up to **12 l/min**

Max pressure: **350 bar**

1 MODEL CODE

DLWH	/	*	-	2A	/	*	/	6	/	**	/	*
<p>Intrinsically safe valve, poppet type, size 06</p> <p>Certification type:</p> <p>- = Omit for Atex Group II M = Atex Group I (mining) IE = IECEX Group II IEM = IECEX Group I (mining)</p> <p>Configuration:</p> <p>2A = 2 way, open in rest position 2C = 2 way, closed in rest position 3A = 3 way, A-T connection in rest position 3C = 3 way, P-B connection in rest position</p>												
										<p>Seals material, see section 6 :</p> <p>- = NBR PE = FKM BT = HNBR (1)</p> <p>Series number</p>		
										<p>Connector type</p> <p>6 = DIN 43650 (standard)</p>		
										<p>Options (2):</p> <p>R = with check valve on port P WP = prolonged manual override</p>		

(1) Not for certification **M** and **IEM**, Group I (mining)

(2) Possible combined options: all combinations are available

⚠ The pressure at T port makes difficult the manual override operation that can be possible only if its value is lower than 50 bar

2 VALVE CONFIGURATION

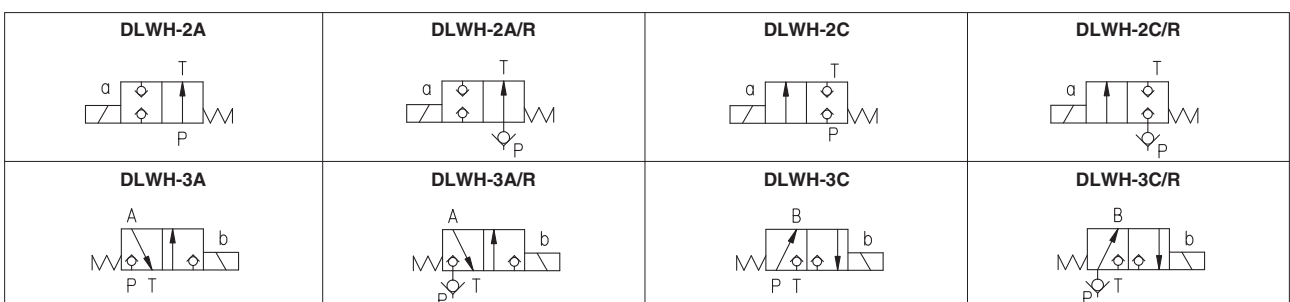

3 GENERAL CHARACTERISTICS

Assembly position / location	The installation of DHW valves with the axis in vertical position is not recommended
Subplate surface finishing	Roughness index Ra 0,4 - flatness ratio 0,01/100 (ISO 1101)
MTTFd values according to EN ISO 13849	150 years, for further details see technical table P007
Ambient temperature	Standard = -20°C ÷ +60°C /PE option = -20°C ÷ +70°C /BT option = -40°C ÷ +70°C
Storage temperature range	Standard = -20°C ÷ +70°C /PE option = -20°C ÷ +70°C /BT option = -40°C ÷ +70°C
Surface protection	Zinc coating with black passivation (body and solenoid housing)
Compliance	Intrinsically safe protection, see section 7

4 HYDRAULIC CHARACTERISTICS

Operating pressure	Ports P,A,B: 350 bar; Port T 160 bar
Rated flow	See Q/Δp diagrams at section 9
Maximum flow	12 l/min , see operating limits at section 10

5 ELECTRICAL CHARACTERISTICS - see also section 7

Nominal resistance at 20°C	150 Ω
Coil insulation	Class H
Working voltage	12 ÷ 26 V
Minimum supply current	65mA, from I.S. barriers
Protection degree	IP66
Duty factor	100%
Electrical connector	DIN 43650 2 pin+GND

6 SEALS AND HYDRAULIC FLUIDS - for other fluids not included in below table, consult our technical office

Seals, recommended fluid temperature	NBR seals (standard) = -20°C ÷ +60°C, with HFC hydraulic fluids = -20°C ÷ +50°C FKM seals (/PE option) = -20°C ÷ +80°C HNBR seals (/BT option) = -40°C ÷ +60°C, with HFC hydraulic fluids = -40°C ÷ +50°C		
Recommended viscosity	15 ÷ 100 mm ² /s - max allowed range 2.8 ÷ 500 mm ² /s		
Max fluid contamination level	ISO 4406 class 20/18/15 NAS 1638 class 9, see also filter section at www.atos.com or KTF catalog		
Hydraulic fluid	Suitable seals type	Classification	Ref. Standard
Mineral oils	NBR, FKM, HNBR	HL, HLP, HLPD, HVL, HVLDP	DIN 51524
Flame resistant without water	FKM	HFDU, HFDR	ISO 12922
Flame resistant with water	NBR, HNBR	HFC	

 The ignition temperature of the hydraulic fluid must be 50°C higher than the max solenoid surface temperature

(1) Performance limitations in case of flame resistant fluids with water:

- max operating pressure = 210 bar
- max fluid temperature = 50°C

7 CERTIFICATION DATA

Valve type	DLWH		DLWH/IE		DLWH/M			DLWH/IEM				
Certification	ATEX (Group II)		IECEX (Group II)		ATEX (mining) (Group I)			IECEX (mining) (Group I)				
Solenoid code	OW-18/6		OWI-18/6		OWM-18/6			OWIM-18/6				
Type examination certificate (1)	CESI 02 ATEX 013		IECEX CES 12.0017		CESI 02 ATEX 013			IECEX CES 12.0017				
Method of protection	Ex II 1G Ex II 1G Ex II 1G		Ex ia IIC Ex ia IIB Ex ia IIA		T6 Ga T6 Ga T5 Ga		Ex I M2			Ex ia I Mb Ex ib I Mb		
Electrical characteristics	Ui [V]	28	28	27	19,5	19,11	28	28	27	19,5	19,11	12,4
	Ii [mA]	396	250	130	360	360	396	250	130	360	360	2200
	Pi [W]	2,8	1,8	0,9	1,64	1,72	2,8	1,8	0,9	1,64	1,72	6,82
	Ci , Li	≅ 0										
Temperature class	T6 for Ex ia IIB/IIC		T5 for Ex ia IIA		-							
Surface temperature (ambient temp. +60°C)	≤ 85°C for T6		≤ 100°C for T5		≤ 150°C							
Ambient temperature	-20 ÷ +60°C		-40 ÷ +60°C (2)		-20 ÷ +60°C							
Applicable standards	EN 60079-0:2012+A11:2013 EN 60079-1:2014 EN 60079-31:2014						IEC 60079-0:2017 IEC 60079-1:2017-04 IEC 60079-31:2013					

(1) The type examiner certificates can be downloaded from www.atos.com

(2) Only for /BT option

 **WARNING: service work performed on the valve by the end users or not qualified personnel invalidates the certification**

8 SOLENOIDS WIRING

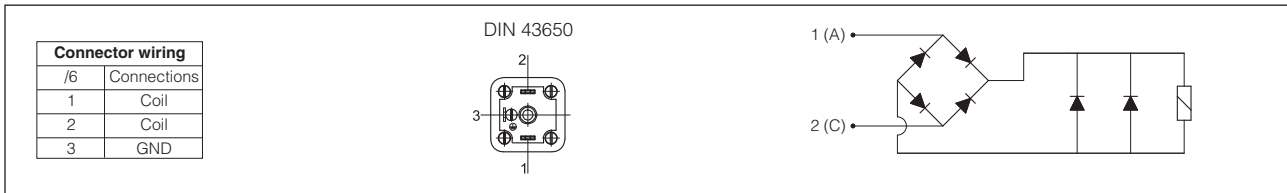

9 Q/Δp DIAGRAMS based on mineral oil ISO VG 46 at 50°C

configuration	Flow direction			
	2A	2C	3A	3C
P→A / P→B (1)	1	2	4	3
A→T / B→T	-	-	5	4

(1) For two-way valves pressure drop refers to P→T

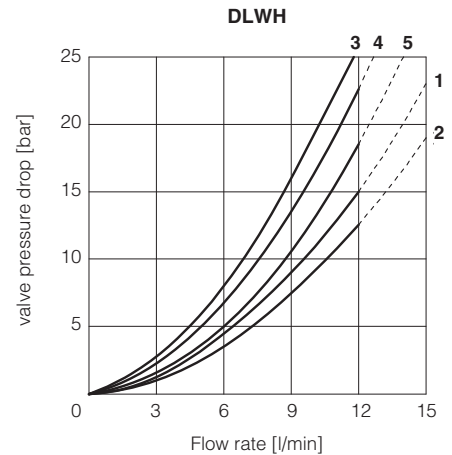

10 OPERATING LIMITS based on mineral oil ISO VG 46 at 50°C

The diagrams refer to warm solenoids and power supply provided by the Atos barrier type **Y-BXNE-412**. In case of asymmetric flow the operating limits must be reduced.

configuration	2A	2C	3A	3C
Diagram	1	1	2	3

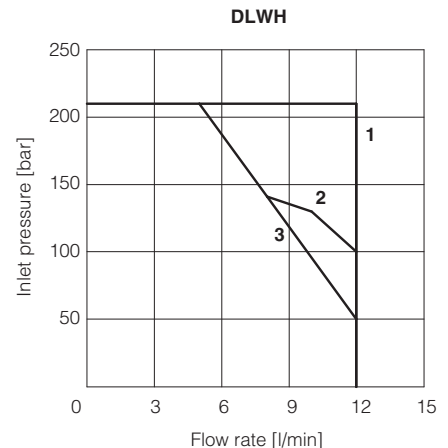

11 INTERNAL LEAKAGES

DLWH internal leakages based on mineral oil ISO VG 46 at 50°C less than 5 drops/min (0,36 cm³/min) at max pressure.

12 INTRINSICALLY SAFE BARRIERS - see tech. table **GX010**

The electric supply to these valves must be done through intrinsically safe barriers situated out of potentially flammable environment (i.e. in safe zone), which limit the electric current to the intrinsically safe solenoid. The "intrinsically safe" circuit is virtually unable to produce electrical surges or thermic effects able to cause explosion in hazardous environments also in presence of specific break-down situations. The intrinsically safe barriers must be approved and certified according to the Ex ia protection mode.

To select the proper intrinsically safe barriers following data must be considered:

- 1) V_{max} and I_{max} of the solenoid as specified in section 7 must not be exceeded also in fault conditions;
- 2) the resistance of the solenoid is 150 Ω and the current supplied by the barrier, in normal operation condition, must be over the min. limit (65 mA) to ensure the valve correct operation (over 70 mA for max performances).

The barriers type **Y-BXNE 412** are galvanically isolated electronic devices, complying with European Norms EN60079-0/06, EN60079-11/07 and ATEX certified according to protection mode Ex ia IIC.

These barriers ensure the optimized functioning of the Atos valves up to the max operating limits specified in section 4.

The barriers Y-BXNE-412 are double channel type, suitable to operate valves with double or single solenoid. Two single solenoid valves can be connected to the barrier (one to each channel) but they cannot be contemporary operated.

MODEL CODE OF I.S. BARRIER

Y-BXNE 412 00	*
Supply voltage	
E = 110/230 V _{AC}	
2 = 24÷48 V _{DC}	

13 INSTALLATION DIMENSIONS [mm]

DLWH-2A, DLWH-2C

ISO 4401: 2005

Mounting surface: 4401-03-02-0-05

(see table P005)

Fastening bolts:

4 socket head screws M5x50 class 12.9

Tightening torque = 8 Nm

Seals: 2 OR 108

Diameter of ports P, T: Ø 7,5 mm (max)

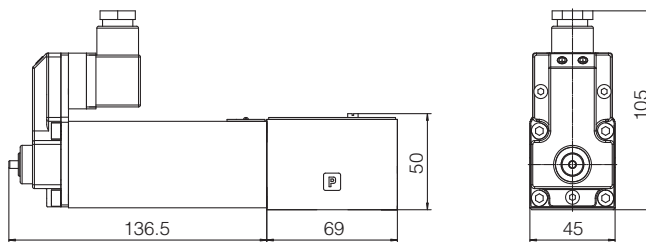

Valve's bottom view

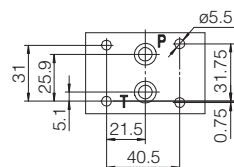

P = PRESSURE PORT

T = USE PORT

DLWH-3A, DLWH-3C

ISO 4401: 2005

Mounting surface: 4401-03-02-0-05

(see table P005)

Fastening bolts:

4 socket head screws M5x50 class 12.9

Tightening torque = 8 Nm

Seals: 4 OR 108

Diameter of ports P, A, B, T: Ø 7,5 mm (max)

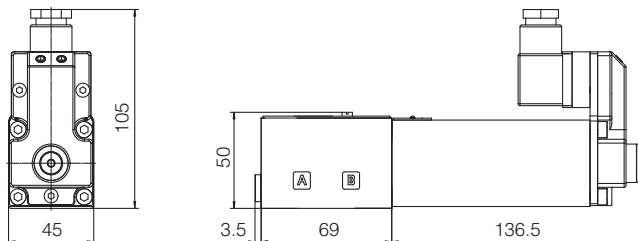

Valve's bottom view

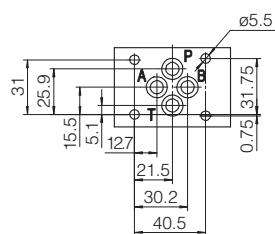

P = PRESSURE PORT

A = USE PORT

(not used for DLAH-3C version)

B = USE PORT

(not used for DLAH-3A version)

T = TANK PORT

Mass [kg]	
DLWH-02	2,3
DLWH-03	2,3

DLWH/M
(different cover shape)

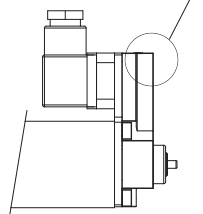

Option **AWP**

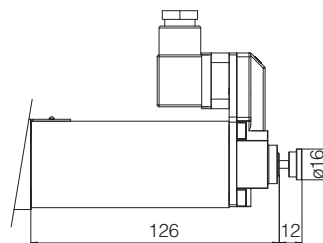

Note: the connector is supplied with the valve

14 RELATED DOCUMENTATION

- X010** General guideline for ex-proof components
- P005** Mounting surfaces for electrohydraulic valves