

Basics for digital electrohydraulics

1 DIGITAL TECHNOLOGY FOR PROPORTIONAL VALVES

Modern world is driven by digital electronics: computers, automation systems, cars and missiles, telecommunications and advanced network are all based on digital technology... ..thanks to its typical benefits in comparison with analog: fast and powerful data processing, easy programmability, high immunity to electromagnetic noise, process parameters and data storage.

In electrohydraulics, digital electronics gives important advantages:

- better performances of electrohydraulic components: hysteresis, response time, linearity;
- numerical software setting of hydraulic parameters (scale, bias, ramp, compensation of non-linearities) for full repeatability and easy data storage
- diagnostic (fault, monitor) and computer assisted maintenance of machines and systems;
- direct interfacing to field-bus networks.

Atos, leader in pioneering proportional electrohydraulics, is active from many years on digital electrohydraulics including: simulation models of valves and systems, research and testing of new DSP microcontrolles, R&D of new solutions.

New digital electrohydraulics with on board electronics enable new functionalities within the conventional control architectures and represent the fundamental premise to realize new compact machines with high technological contents.

The digital electronics integrate several logic and control functions (distributed intelligence) and make it feasible and inexpensive the introduction in the hydraulic system of the most modern fieldbus communication networks.

Atos digital driver's range replicate the analogue one:

- **E-RI-AES** for valves without transducer
- **E-RI-TES/LES** for valves with single/double LVDT transducer
- **E-RI-TERS** for valves with integral pressure transducer
- **E-RI-AERS** for valves predisposed for connection of remote pressure transducer

2 COMMUNICATION INTERFACES

The communication interface is the access port through which the valve receives commands and/or setting parameters and it returns information to the fieldbus master.

Atos digital proportional valves are available with 3 optional communication interfaces:

- basic **-PS**: serial programming RS232 interface.
The main feature of this basic version is the full interchangeability with the corresponding analog executions, in fact the reference and the monitor signals are analog, whereas the serial interface allows to manage the diagnostics and to set the best configuration of the valve for the application's requirements.
- option **-BC**: CANopen (CanOpen DS408 v1.5 protocol)
- option **-BP**: Profibus DP (Fluid Power Technology protocol).

The valves with option -BC and -BP can be connected to the fieldbus network and thus digitally operated by the machine control unit.

The functional parameters can be set via fieldbus using the standard communication protocol implemented by Atos, or alternatively using the PC graphic software E-SW-BC or E-SW-BP with the relevant USB interface KIT (see tab. G500). For start-up or maintenance operations, the valves with -BC or -BP interfaces can be operated with analogue signals via the 7 (or 12) pins power supply connector.

3 DIGITAL SETTINGS AND DIAGNOSTICS by ATOS PROGRAMMING SOFTWARE

A large number of the functional parameters of the valve can be easily set trough the communication interface, using the Atos E-SW programming software, as:

- the bias and scale
- the ramps, corresponding to the transition time from 0% to 100% of the valve's regulation
- the linearization of the hydraulic regulation
- dither frequency

Many other regulations, including the valve functional diagnostic are available, see tab. G001 for additional information.

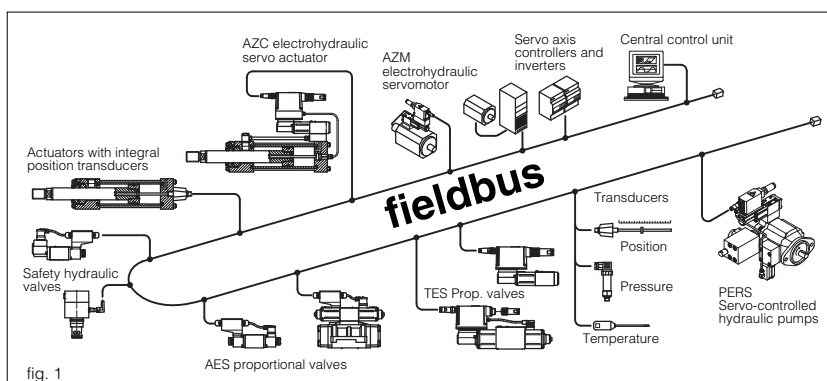

fig. 1



fig. 2 software setting of digital proportionals

4 PRESSURE-FORCE/FLOW COMBINED CONTROLS FOR PROPORTIONAL DIRECTIONAL VALVES, see tab. G212

In most of the machines functions, the typical movement of a single actuator requires direction, speed and sometime force regulations, normally performed by different valves.
 The integral digital drivers with /SP, /SF, /SL options add the pressure or force closed loop to the spool position control of standard proportional directional valves. A single proportional valve with /S* option allows to manage complex machine operations requiring high performance combined regulations (typical application: injection cycle or mould motion in plastic machinery).
 The closed loop pressure or force control requires the installation in the system of one/two remote pressure transducers or a load cell, to be connected to the valve digital driver. The option /SP performs the closed loop pressure control in one direction by using 1 remote pressure transducer (see fig.3). The other two options perform the closed loop force control by means of 2 remote pressure transducers (option /SF, see fig.4) or load cell (option /SL, see fig.5).
 The pressure (force) and flow levels are regulated with independent command signals. The selection from pressure-force to flow control and vice versa is self performed by the digital driver through dedicated algorithm.

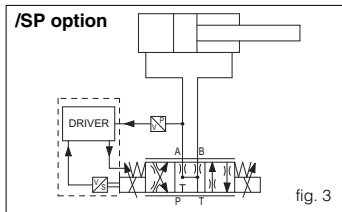

fig. 3

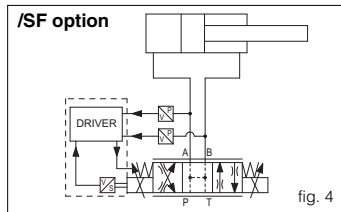

fig. 4

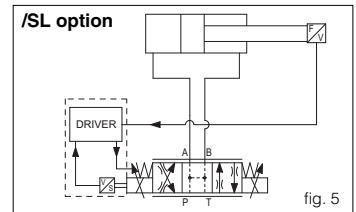

fig. 5

Position transducer

Pressure transducer

Load cell

5 COMBINED P/Q CONTROLS FOR VARIABLE PISTON PUMPS, see tab. A170 and G215

The digital driver E-RI-PES for PVPC-PE(R)S variable displacement axial piston pumps (see fig. 6), integrates the digital combined closed loop pressure and flow control with the electronic max power limitation. The -PERS pump directly controls the system pressure and the speed of machine actuators.
 A multiple set of PID parameters can be real time selected during the axis motion via the 12 pin connector (option /S) or through the -BC or -BP interfaces, to optimize the P/Q control performances.

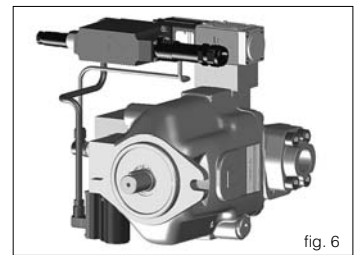

fig. 6

6 EX-PROOF INTEGRAL DIGITAL CONTROLS, see tab. F250

The ex-proof proportional valves with new ex-proof integral digital drivers provide consistent advantages as compact execution, simplified wiring and reduced risk of electromagnetic disturbances.
 They allow to exploit all the performances provided by the standard digital electronics: software setting of the main functional parameters (bias, scale, ramps regulation, linearization of the hydraulic characteristic) and the possibility to integrate the valves into a fieldbus network, thanks to the optional -BC and -BP interfaces.
 The drivers are ATEX certified and they are available for the full range of ex-proof proportional valves, open and closed loop.



fig. 7

7 DIGITAL SOLUTIONS FOR OPEN LOOP SERVOSYSTEMS, see tab. G120

The concept of distributed intelligence is applied in its easiest form to the drivers type E-RI-AEG.
 This controller is a cycle generator for proportional directional valves without position transducer, which self-manages repetitive open loop "fast-slow speed" motion cycles, without auxiliary axis controller.
 The cycle phases can be operated through up to five inductive proximity sensors to be interfaced to the driver (see fig.8) or by on-off command signals from the machine CNC.
 For any of the cycle phases it is possible to set into the driver speed and ramps.

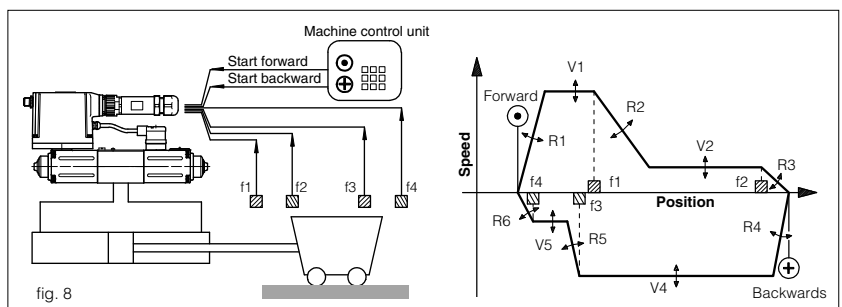

fig. 8

8 DIGITAL AXIS CONTROLLERS, see tab. G003

The digital axis controllers perform accurate closed loop position controls with additional speed or pressure/force regulations.
 They are available in three executions with different characteristics to better comply the several applications requirements:
 Z-RI-TEZ, integral to the proportional directional valve ①. It can be supplied pre-assembled with Atos servocylinder ② making a compact motion control unit called "servoactuator" (see fig.9)
 Z-ME-KZ, Eurocard format, with extended electronic interfaces
 Z-BM-HZ, DIN-rail mounting, high performance multiple axes controllers

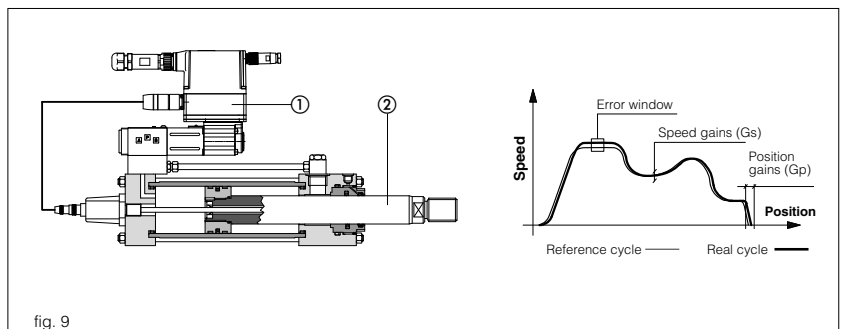

fig. 9